



## شرکت آسان راه البرز

با 40 سال تجربه در زمینه ی واردات ماشین آلات معدنی، راهسازی و صنعتی و با استفاده از مدیران خبره، کارشناسان مجرب و پرسنل با تجربه آموزش دیده از فعالترین شرکت های تجاری در ایران می باشد. این شرکت در سال 1389 موفق به اخذ نمایندگی رسمی از شرکت هیوندای کره جنوبی و نمایندگی انحصاری محصولات اوردایم برای واردات، فروش و خدمات پس از فروش ماشین آلات سنگین، راهسازی، معدنی و صنعتی در ایران گردید.

این شرکت با توجه به نیاز مشتریان و محیط های کاری موجود اقدام به واردات انواع ماشین آلات راهسازی از قبیل لودر چرخ لاستیکی، بیل هیدرولیکی چرخ لاستیکی و چرخ زنجیری و انواع لیفتراک با بازه تناژی بالا و انواع چکش های هیدرولیکی و انواع ژنراتورهای برق (دیزلی و دوگانه سوز) نموده است و هر دوره با توجه به درخواستها بر تنوع محصولات خود اضافه میکند.



## Dimension

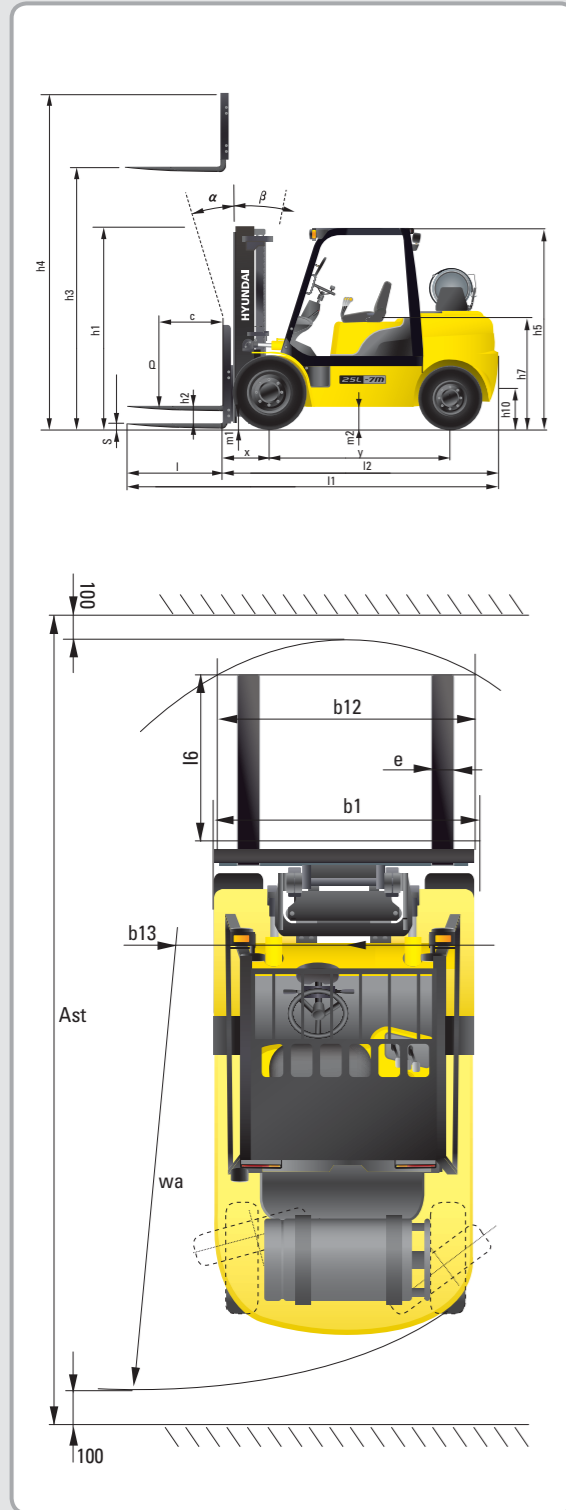

## Specification

Identification			
1.1	Manufacturer	Hyundai	Hyundai
1.2	Manufacturer's type designation	25L(G)-7M	30L(G)-7M
1.3	Drive: electric (battery or mains), diesel, petrol, fuel gas, manual	LP / GAS	LP / GAS
1.4	Type of operation: hand, pedestrian, standing, seated, order-picker	seated	seated
1.5	Load capacity / rated load	Q (kg)	2,500
1.6	Load center distance	c (mm)	500
1.8	Load distance, center of drive axle to fork	x (mm)	468
1.9	Wheelbase	y (mm)	1,650
Weights			
2.1	Service weight	kg	3,860
2.2	Axle loading, loaded front/rear	kg	5,608 / 752
2.3	Axle loading, unloaded front/rear	kg	1,684 / 2,176
Wheels, Chassis			
3.1	Tires: solid rubber, superplastic, pneumatic, polyurethane	Pneumatic	Pneumatic
3.2	Tires size, front	7.00 - 12 - 12PR	8.15 - 15 - 14PR
3.3	Tires size, rear	6.50 - 10 - 12PR	6.50 - 10 - 12PR
3.5	Wheels, number front x rear (x = driven wheels)	2 x 2	2 x 2
3.6	Track width, front	b10 (mm)	965
3.7	Track width, rear	b11 (mm)	980
Basic Dimensions			
4.1	Mast / fork carriage tilt forward / backward (α / β) degrees	6 / 10	6 / 10
4.2	Lowered mast height	h1 (mm)	2,175
4.3	Free lift	h2 (mm)	155
4.4	Lift height	h3 (mm)	3,300
4.5	Extended mast height	h4 (mm)	4,485
4.7	Overhead Guard (cab) height	h5 (mm)	2,180
4.8	Seat height / standing height	h7 (mm)	1,110
4.12	Coupling height	h10 (mm)	283
4.19	Overall length	l1 (mm)	3,639
4.20	Length to face of forks	l2 (mm)	2,607
4.21	Overall width	b1 (mm)	1,160
4.22	Fork dimensions	s / e / l (mm)	1,050 x 100 x 45
4.23	Fork carriage ISO 2328, class / type A,B	II / A	III / A
4.24	Fork-carriage width	b12 (mm)	1,102
4.31	Ground clearance, loaded, under mast	m1 (mm)	130
4.32	Ground clearance, centre of wheelbase	m2 (mm)	171
4.33	Aisle width for pallets 1000 x 1200 crossways	Ast (mm)	3,981
4.34	Aisle width for pallets 800 x 1200 lengthways	Ast (mm)	4,181
4.35	Turning radius	Wa (mm)	2,313
4.36	Smallest pivot point distance	b13 (mm)	714
Performance Data			
5.1	Travel speed, Unloaded	km/h	17.5
5.2	Lift speed, Loaded/Unloaded	mm/s	600 / 610
5.3	Lowering speed, Loaded/Unloaded	mm/s	500 / 450
5.5	Drawbar pull, Loaded	kg	2,569
5.7	Gradient performance, Loaded/Unloaded	%	39.3 / 22.0
5.10	Service brake		Foot
Engine			
6.1	Engine manufacturer / type		GM 3.0L
6.2	Engine power acc. to ISO 1585 (gasoline)	kW	47.8 (50)
6.3	Rated speed	1/min	2,400
6.4	No. of cylinder / cubic capacity	/cm³	4 / 2,967
Other Details			
8.2	Type of drive control		Power Shift
8.3	Operating pressure	bar	220 / 165
8.4	Oil volume	l	30
8.5	Noise	db(A)	80



Some of the photos may include optional equipment.

HYUNDAI LPG/GASOLINE FORKLIFT TRUCKS Applied Tier 4 Engine

# 25/30/33L(G)-7M

**HYUNDAI FORKLIFT**  
HEAVY INDUSTRIES CO.,LTD.

Head Office (Sales Office)  
14th Fl., Hyundai Bldg. 75, Yulgok-ro, Jongno-gu, Seoul 110-796, Korea  
TEL (82) (2) 746-4609, 4753 / FAX (82) (2) 746-7444, 7445

Americas Operation : Hyundai Construction Equipment Americas, Inc.  
6100 ATLANTIC BOULEVARD NORCROSS GA 30071 U.S.A.  
TEL (1) 847-678-823-7802 / FAX (1) 847-678-823-7778

Europe Operation : Hyundai Heavy Industries Europe N.V.  
VOSSENDAAL 11, 2440 GEEL, BELGIUM  
TEL (32) 14-56-2200 / FAX (32) 14-59-3405



PLEASE CONTACT

www.hyundai-ce.com

2013. 10 Rev.2

**HYUNDAI**  
HEAVY INDUSTRIES CO.,LTD.

We build a better future



# NEW criteria of Forklift Trucks

Hyundai introduces a new line of 7M series  
LPG / Gasoline forklift trucks.  
Excellent power and performance make your  
business more profitable.

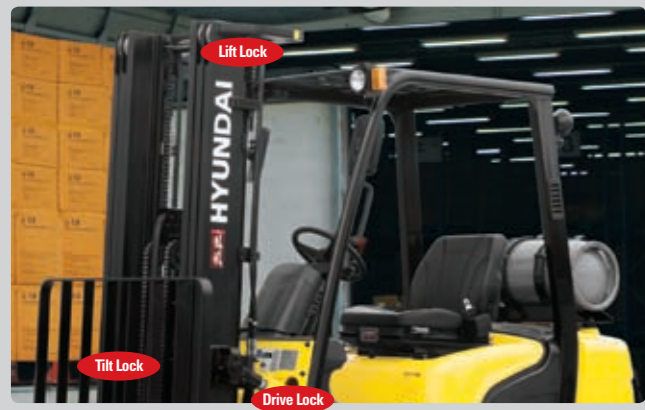

### OPSS (Operator Presence Sensing System)

Control of mast tilting, lifting and lowering is not possible through operation of the appropriate control when the operator is not in the seated position. (Option)

■ Some of the photos may include optional equipment.



## The new master on the job-site!

Smooth running, efficient and ergonomically designed, 25L(G)/30L(G)/33L(G)-7M series are made to meet your needs.

**47.8kW/2,400rpm** (50kW/2,400rpm : Gasoline)

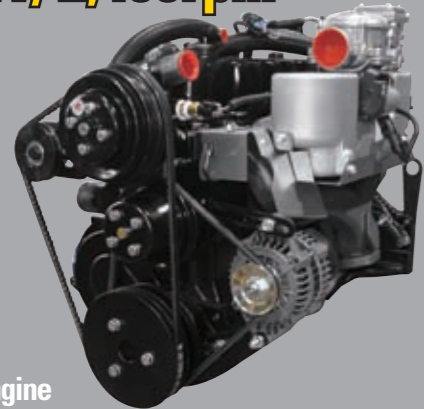

### Powerful Engine GM 3.0L Engine

Market approved quality of GM 3.0L engine ensures incomparable performance, durability and additional value to the machine. Powerful and efficient engine provides excellent fuel consumption and excellent torque improved operator's comfort.  
(EPA/CARB Tier-IV Certified)

### Fast and Stable Performance

Being able to quickly raise and lower the mast, as well as tilt it forward and backward, provides the best operational conditions during unloading.

When the truck is fully loaded, mast lowering speed is carefully controlled to ensure safety by the down control valve.

Mast(Lift and Tilt) Look System. (Option)



Some of the photos may include optional equipment.

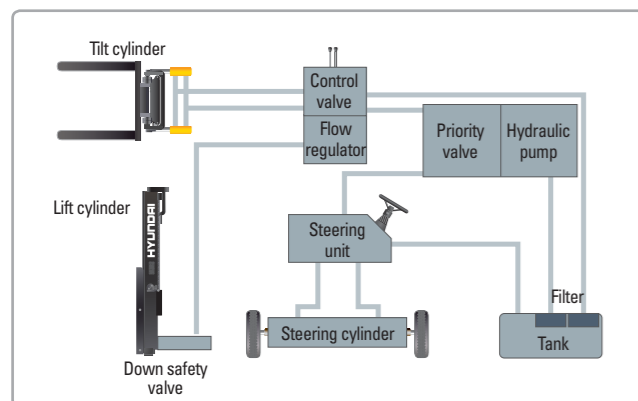

### State-of-the-art Hydraulic System

The latest large-capacity hydraulic system reacts quickly during operation, and a low-noise control valve increases both efficiency and durability.



### Fully Hydrostatic Power Steering

A hydraulic steering system always guarantees smooth and flexible steering, preventing overrun and kick-back.



### Increased Mast Tilting Angle

Utilizing the mast tilting angle of 6 degrees forward and 10 degrees backward, the operator can safely and rapidly perform loading and unloading jobs.

### Faster Travel Speed & Better Gradability

The powerful high-output engine provides greater acceleration, better gradability and faster travel speed on any tough terrains or slopes.

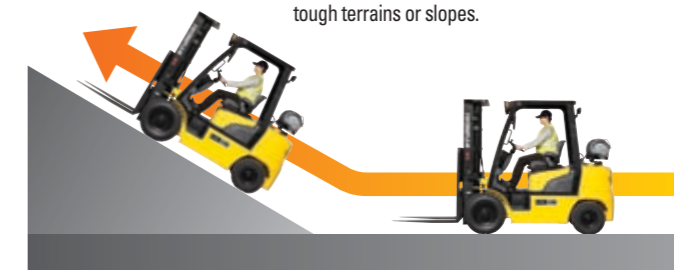

### Gradability(Loaded)

25L(G)-7M : 39.3%  
30L(G)-7M : 32.1%  
33L(G)-7M : 29.0%

### Travel Speed(Unloaded)

25L(G)-7M : 17.5 km/h  
30L(G)-7M : 18.5 km/h  
33L(G)-7M : 18.5 km/h



## Ergonomic operator friendly compartment design!

A design based on human engineering relieves fatigue and increases operator's efficiency.

### Operator Friendly Gauges and Water-resistant Monitor Panel

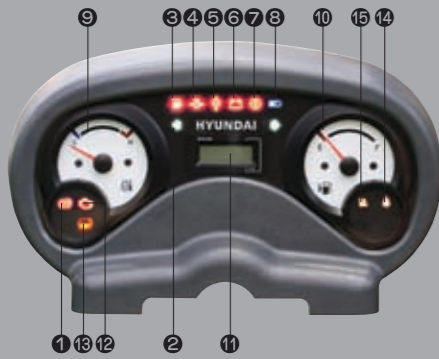

- 1 Parking brake lamp
- 2 Directional indicators
- 3 Fuel warning lamp
- 4 Engine oil warning lamp
- 5 Transmission oil temperature warning lamp
- 6 Battery charging warning lamp
- 7 Air cleaner filter warning light
- 8 Working light indicator
- 9 Water temperature gauge
- 10 Fuel gauge
- 11 Hour meter
- 12 Engine check lamp
- 13 Brake oil warning lamp
- 14 Seat belt warning
- 15 OPS warning



**Full Suspension Seat**  
An attractive and adjustable seat, based on a human engineering design, provides great comfort, safety and durability.



**New High Visibility for Safe Operation**  
The operator is able to work with increased safety and accuracy due to a wider view mast.



**Travel Speed Control System (Option)**

- In-Door : Max. Travel Speed (5~16 km/h)
- Out Door : Max Travel Speed (Max vehicle speed)

■ Some of the photos may include optional equipment.



**Ergonomically Positioned Pedals**  
Based on human engineering, the accelerator, brake and inching pedals are optimally positioned for convenience while operating the equipment.



**Cup Holder & Console Box**  
Additional storage spaces are located inside the operating space for operator's convenience.



**Quick Response of Operating Control Levers**  
Only minimal operator's effort is required for precise, safe and productive control.



**Adjustable Steering Wheel**  
Steering wheel with horn button can be adjusted by a lever on the right-hand side for the most comfortable operator position.



**Easy and Safe Shift Lever**  
A single lever on the left side of the steering column gives the operator fast, easy control of direction. The lever must be in the neutral position before the engine can be started.



**Secondary Horn**  
Secondary Horn gives access to lights and horn.



## Danger-free through high durability!

Safety and durability are priorities in design of the equipment.



### Strong Overhead Guard

The safety overhead guard meets ISO 6055 regulation and protects the operator during hazardous jobs.



### Parking Brake

Ratchet type parking brake requires less effort from the operator to set.



### Highly Durable Split Type Drive Axle

The bevel gear set and hub reduction axle smoothly delivers desired torque to the drive wheels.



■ Some of the photos may include optional equipment.



### Large Footboard & Hand Grip

Wide "open" step offers convenience and safety when entering and exiting truck.



### Expansion Bellows

The expansion bellows absorbs vibration and reduces noise generated from the exhaust gas system and also extends the life cycle of exhaust gas system.



### Electrically Monitored Air Filter

Air cleaner sensor alerts the operator of a restricted air filter and allows replacement before damage.

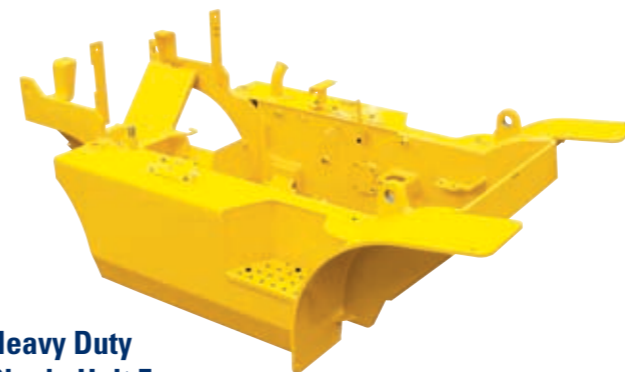

### Heavy Duty Single Unit Frame

Heavy duty single unit type frame, designed on the basis of accurate structural analysis, guarantees durability and safety.



### Bright, Protected Headlights

Bright, Protected head lights are positioned for exceptional visibility.

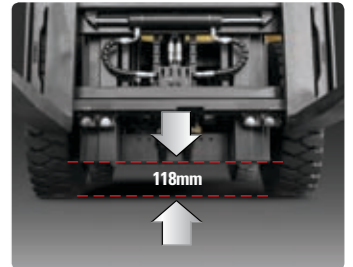

### Ground Clearance

The engine and transmission are assembled horizontally and positioned high in the frame to protect major components during operation on rugged surface.



## Designed for quick and easy service!

An ideal arrangement of component parts ensures easy access and convenience for maintenance.



### Easy Change Air Cleaner

The air filter is readily accessible for cleaning or replacement. (6inch Cyclone Type)



### Fast Service Access for Daily Fluids Check



**Rotational Battery Installation**

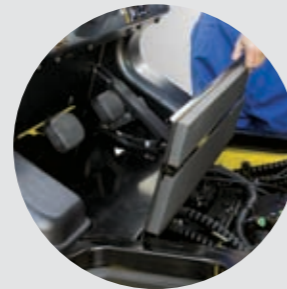

**One Touch, No Tool Floor Plate**



**Removable Side Panels for Ease of Service**



### Improvement in Maintenance of Electric Parts

Various electric parts are centralized in dash board resulting in effortless troubleshooting.



### Easy Maintenance Oil Check

The T/M oil level can be checked easily without any disassembly.



### Brake Fluid Reservoir with Level Switch

When brake oil level become lower than Min. the warning lamp on the cluster lights on.



### An Accessible, Compact Fuse Box for Easy Inspection

## Mast Specification

Mast Type	Maximum Fork Height (mm)		Overall Height Lowered (mm)			Tilt Angle (deg)		Free Lift (mm)						Load Capacity w/ o Integral Side Shift 500mm LC (kg)						Load Capacity w/ Integral Side Shift 500mm LC (kg)						Truck Weight Unload (kg)									
								With Backrest			With/ o Backrest			Single Tire			Double Tire			Single Tire			Double Tire			Single Tire			Double Tire						
	25L(G)-7M	30L(G)-7M	25L(G)-7M	30L(G)-7M	33L(G)-7M	Fwd	Bwd	25L(G)-7M	30L(G)-7M	33L(G)-7M	25L(G)-7M	30L(G)-7M	33L(G)-7M	25L(G)-7M	30L(G)-7M	33L(G)-7M	25L(G)-7M	30L(G)-7M	33L(G)-7M	25L(G)-7M	30L(G)-7M	33L(G)-7M	25L(G)-7M	30L(G)-7M	33L(G)-7M	25L(G)-7M	30L(G)-7M	33L(G)-7M	25L(G)-7M	30L(G)-7M	33L(G)-7M				
2-Stage Limited Free Lift	V300	3000	2900	2025	2040	2040	6	10	155	155	155	155	155	155	2500	3000	3300	2500	3000	3300	2500	3000	3300	2500	3000	3300	2500	3000	3300	3840	4176	4382	3977	4262	4479
	V330	3300	3200	2175	2190	2190	6	10	155	155	155	155	155	155	2500	3000	3300	2500	3000	3300	2500	3000	3300	2500	3000	3300	2500	3000	3300	3877	4214	4422	4013	4300	4519
	V370	3700	3600	2425	2440	2440	6	10	155	155	155	155	155	155	2500	3000	3300	2500	3000	3300	2500	3000	3300	2500	3000	3300	2500	3000	3300	3899	4237	4446	4035	4323	4543
	V400	4000	3900	2575	2590	2590	6	10	155	155	155	155	155	155	2450	3000	3300	2500	3000	3300	2475	2950	3200	2500	2975	3300	3929	4268	4478	4065	4354	4575			
	V430	4300	4200	2725	2740	2740	6	6	155	155	155	155	155	155	2400	2925	3200	2475	3000	3300	2400	2875	3100	2450	2925	3300	3981	4320	4531	4117	4407	4628			
	V450	4500	4400	2875	2890	2890	6	6	155	155	155	155	155	155	2350	2875	3150	2475	2950	3300	2350	2825	3030	2400	2875	3300	4003	4343	4555	4139	4429	4652			
2-Stage Full Free Lift	V470	4700	4600	2975	2990	2990	6	6	155	155	155	155	155	155	2325	2825	3100	2400	2925	3300	2325	2750	3000	2375	2825	3200	4017	4358	4571	4153	4445	4668			
	V500	5000	4900	3125	3140	3140	6	6	155	155	155	155	155	155	2250	2775	3050	2350	2850	3250	2275	2700	2930	2350	2775	3150	4039	4381	4594	4175	4467	4691			
	VF290	2932	2900	2025	2040	2090	6	6	845	860	910	1377	1314	1269	2500	3000	3300	2500	3000	3300	2500	3000	3300	2500	3000	3300	3886	4216	4427	4023	4302	4518			
	VF320	3232	3200	2175	2190	2240	6	6	995	1010	1060	1527	1464	1419	2500	3000	3300	2500	3000	3300	2500	3000	3300	2500	3000	3300	3920	4251	4462	4057	4337	4553			
	TF370/TS370	3700	3700	1825	1840	1890	6	6	645	660	710	1177	1114	1069	2460	3000	3250	2500	3000	3300	2450	2900	3300	2450	2900	3300	3977	4326	4569	4114	4412	4660			
	TF400/TS400	4000	4000	1925	1940	1990	6	6	745	760	810	1277	1214	1169	2400	2925	3160	2475	3000	3300	2400	2850	3040	2450	2900	3300	4001	4350	4591	4138	4436	4682			
3-Stage Full Free Lift	TF430/TS430	4300	4300	2025	2040	2090	6	6	845	860	910	1377	1314	1269	2350	2850	3100	2425	2925	3300	2350	2775	3000	2400	2825	3200	4019	4372	4612	4156	4458	4703			
	TF450/TS450	4500	4500	2125	2140	2190	6	6	945	960	1010	1477	1414	1369	2300	2800	3030	2375	2875	3250	2325	2725	2920	2350	2775	3150	4041	4397	4634	4178	4483	4725			
	TF470/TS470	4700	4700	2175	2190	2240	6	6	995	1010	1060	1527	1464	1419	2250	2775	3000	2350	2825	3200	2275	2675	2900	2300	2725	3100	4054	4412	4647	4191	4498	4738			
	TF500/TS500	5000	5000	2275	2290	2340	6	6	1095	1110	1160	1627	1564	1519	2200	2700	2940	2275	2775	3125	2200	2600	2840	2275	2675	3030	4076	4434	4670	4213	4520	4761			
	TF550/TS550	5500	5500	2475	2490	2540	6	6	1295	1310	1360	1827	1764	1719	1700	2600	2900	2200	2675	3000	1700	2525	1900	2200	2575	2900	4116	4478	4714	4253	4564	4805			
	TF600/TS600	6000	6000	2675	2690	2740	6	6	1495	1510	1560	2027	1964	1919	1150	1600	1100	2100	2575	2900	1150	1750	1000	2100	2475	2800	4180	4548	4786	4317	4634	4877			
4-Stage Full Free Lift	QF610	6115	6115	2160	2175	2225	3	3	997	955	1045	1512	1449	1449	1600	1800	1950	1850	2350	2830	1530	1710	1850	1750	2220	4391	4695	4860	4527	4782	4937				
	QF660	6615	6615	2360	2375	2425	3	3	1197	1195	1245	1712	1649	1649	1500	1700	1850	1750	2200	2700	1430	1610	1750	1650	2070	2600	4450	4755	4920	4586	4842	4996			
	QF700	7015	7015	2460	2475	2525	3	3	1297	1295	1345	1812	1749	1749	1400	1500	1500	1700	2150	2580	1330	1420	1400	1600	2020	2460	4481	4785	4950	4617	4872	5027			
	QF745	7465	7465	2610	2625	2675	3	3	1447	1445	1495	1962	1899	1899	1100	1200	1000	1600	2050	2440	1040	1120	900	1510	1930	2340	4527	4831	4996	4663	4918	5073			
QF790	7915	7915	2760	2775	2825	3	3	1597	1595	1645	2112	2049	2049	700	750	550	1000	1100	1300	650	680	500	920	990	1200	4627	4932	5097	4763	5019	5173				

\* TS-Mast : Wide Visible 3 Stage Full Free Lift Mast with 2 Free Lift Cylinders.

## Load Capacity

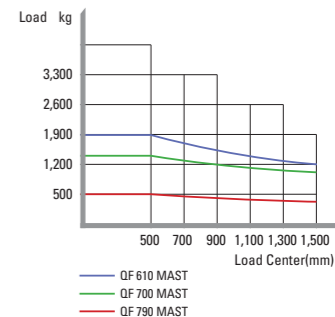
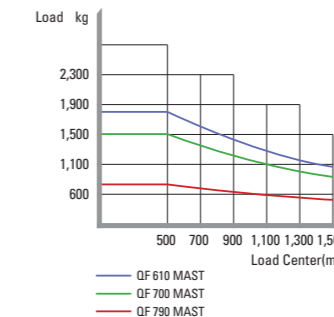
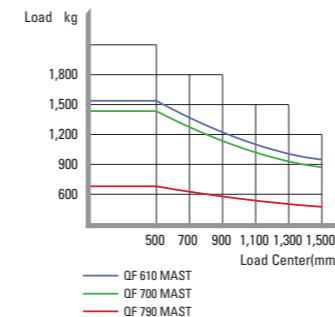
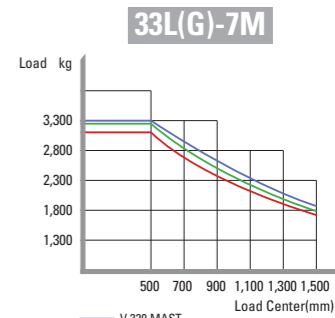
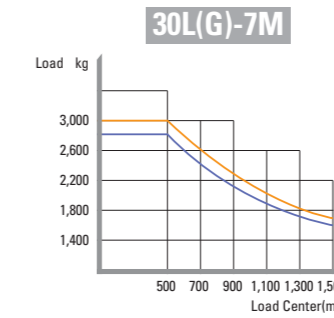
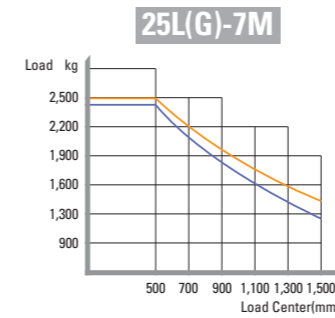

## Optional Items

- CABIN & HEATER
- SIDE SHIFT / INTEGRAL SIDE SHIFT
- FORK (L x W x T) (mm)
 

25L(G)-7M	900 x 100 x 45	1,000 x 100 x 45	1,050 x 100 x 45
	1,200 x 100 x 45	1,350 x 100 x 45	1,500 x 100 x 45
	1,650 x 100 x 45	1,800 x 100 x 45	

- 30/33L(G)-7M
 

900 x 122 x 45	1,050 x 122 x 45	1,150 x 122 x 45
1,200 x 122 x 45	1,350 x 122 x 45	1,500 x 122 x 45
1,650 x 122 x 45	1,800 x 122 x 45	1,970 x 122 x 45
2,120 x 122 x 45	2,300 x 122 x 45	2,400 x 122 x 45
- OVER SHOE(mm) : 1,300, 1,500, 1,700, 1,800
- TILTING : 6/6°, 3/3°

- TIRE : Cushion, No-marking, Double
- SEAT : Pocket, Arm Rest, Hip Rest
- LPG CLAMP : Swing Out, Swing Down
- M.C.V : 4-Spool
- ATTACH PIPING : 3 Spool-piping, 4 Spool-piping
- MASTER SWITCH / HAZARD SWITCH
- BEACON LAMP / WORK LAMP
- SPEED CONTROL SENSOR